

CONTENT (MLCC)

E STANDARD NUMBER..... 3

STRUCTURE 4

ORDERING CODE 4

 HIGH Q & LOW ESR TYPE (Q SERIES)..... 5

 TEST SPEC. 8

PACKAGE 10

OTHERS 12

E Standard Number

E3	1.0						2.2						4.7											
E6	1.0			1.5			2.2			3.3			4.7			6.8								
E12	1.0	1.2	1.5	1.8	2.2	2.7	3.3	3.9	4.7	5.6	6.8	8.2												
E24	1.0	1.1	1.2	1.3	1.5	1.6	1.8	2.0	2.2	2.4	2.7	3.0	3.3	3.6	3.9	4.3	4.7	5.1	5.6	6.2	6.8	7.5	8.2	9.1

Structure



Ordering Code

C 1005 NP0 101 J G T Q

PRODUCT CODE

C = MLCC

SIZE in mm (EIA CODE, in inch)

0402(01005)	0603(0201)	1005 (0402)	1608 (0603)	2012 (0805)
3216 (1206)	3225(1210)	4520 (1808)	4532 (1812)	

T. C.

NP0: $0 \pm 30\text{ppm}/^\circ\text{C}$	-55°C to +125°C		
X7R: $\pm 15\%$	-55°C to +125°C	X6S: $\pm 22\%$	-55°C to +105°C
X5R: $\pm 15\%$	-55°C to +85°C	Y5V: $+22\%/-82\%$	-30°C to +85°C

CAPACITANCE CODE

Expressed in pico-farads and identified by a three-digit number.
 First two digits represent significant figures.
 Last digit specifies the number of zeros.
 (Use 9 for 1.0 through 9.9pF ; Use 8 for 0.20 through 0.99pF)

Examples:

Code	Cap (pF)
478	0.47
229	2.2
101	100
102	1000

TOLERANCE CODE

A: $\pm 0.05\text{pF}$	B: $\pm 0.1\text{pF}$	C: $\pm 0.25\text{pF}$	D: $\pm 0.5\text{pF}$	F: $\pm 1\%$	G: $\pm 2\%$
J: $\pm 5\%$	K: $\pm 10\%$	M: $\pm 20\%$	Z: $+80\%/-20\%$		

VOLTAGE CODE

B: 4V	C: 6.3V	D: 10V	E: 16V	F: 25V	N: 35V	G: 50V	H: 100V
J: 200V	K: 250V	L: 500V	M: 630V	P: 1KV	Q: 2KV	R: 3KV	S: 4KV

PACKAGING CODE

T: Paper tape reel Ø180mm (7")	P: Embossed tape reel Ø180mm (7")
N: Paper tape reel Ø250mm (10")	D: Embossed tape reel Ø250mm (10")
A: Paper tape reel Ø330mm (13")	E: Embossed tape reel Ø330mm (13")
W: Special Packing	

Application Code

S: Standard Q: High Q/Low ESR F: Microwave A: Automotive Infotainment with AEC-Q200

High Q & Low ESR Type (Q Series)

■ Feature

1. Ultra-stable
2. Tight tolerance available
3. Low ESR (Frequency is within 2.4GHz)
4. Good frequency performance
5. No aging of capacitance
6. RoHS compliant
7. Halogen Free

■ Application

1. LC and RC tuned circuit
2. Filtering
3. Timing

■ Standard External Dimensions

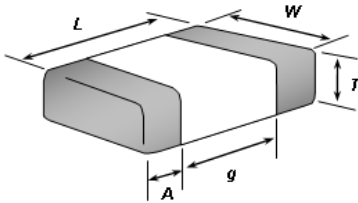

TYPE (EIA Size)	Dimension (mm)				
	L (Length)	W (Width)	T (Max.)	g (Min)	A (Min/Max)
C1005 (0402)	1.0 ± 0.05	0.5 ± 0.05	0.55	0.30	0.15 / 0.35
C1608 (0603)	1.6 ± 0.10	0.8 ± 0.10	0.90	0.50	0.25 / 0.65

■ Part Number & Characteristic

● C1005NP0_Q Series (EIA0402)

RV	DARFON P/N	Measuring Condition	Capacitance		Available Tolerance	Thick. (mm)	Tolerance(mm)		ESR (max.)	Q (min.)	Standard Packing
			Value	Unit			L/W	Thick.			
50V	C1005NP0108□GTQ	1V, 1MHz	0.10	pF	±0.1pF	0.50	±0.05	±0.05	5305	300	Paper, 10Kpcs
	C1005NP0208□GTQ	1V, 1MHz	0.20	pF	±0.25pF, ±0.1pF, ±0.05pF	0.50	±0.05	±0.05	2653	300	
	C1005NP0308□GTQ	1V, 1MHz	0.30	pF	±0.25pF, ±0.1pF, ±0.05pF	0.50	±0.05	±0.05	1768	300	
	C1005NP0408□GTQ	1V, 1MHz	0.40	pF	±0.25pF, ±0.1pF, ±0.05pF	0.50	±0.05	±0.05	1326	300	
	C1005NP0508□GTQ	1V, 1MHz	0.50	pF	±0.25pF, ±0.1pF, ±0.05pF	0.50	±0.05	±0.05	1061	300	
	C1005NP0608□GTQ	1V, 1MHz	0.60	pF	±0.25pF, ±0.1pF, ±0.05pF	0.50	±0.05	±0.05	884	300	
	C1005NP0708□GTQ	1V, 1MHz	0.70	pF	±0.25pF, ±0.1pF, ±0.05pF	0.50	±0.05	±0.05	758	300	
	C1005NP0758□GTQ	1V, 1MHz	0.75	pF	±0.25pF, ±0.1pF, ±0.05pF	0.50	±0.05	±0.05	707	300	
	C1005NP0808□GTQ	1V, 1MHz	0.80	pF	±0.25pF, ±0.1pF, ±0.05pF	0.50	±0.05	±0.05	663	300	
	C1005NP0908□GTQ	1V, 1MHz	0.90	pF	±0.25pF, ±0.1pF, ±0.05pF	0.50	±0.05	±0.05	589	300	
	C1005NP0109□GTQ	1V, 1MHz	1.0	pF	±0.25pF, ±0.1pF, ±0.05pF	0.50	±0.05	±0.05	531	300	
	C1005NP0119□GTQ	1V, 1MHz	1.1	pF	±0.25pF, ±0.1pF, ±0.05pF	0.50	±0.05	±0.05	482	300	
	C1005NP0129□GTQ	1V, 1MHz	1.2	pF	±0.25pF, ±0.1pF, ±0.05pF	0.50	±0.05	±0.05	531	250	
	C1005NP0139□GTQ	1V, 1MHz	1.3	pF	±0.25pF, ±0.1pF, ±0.05pF	0.50	±0.05	±0.05	490	250	
	C1005NP0159□GTQ	1V, 1MHz	1.5	pF	±0.25pF, ±0.1pF, ±0.05pF	0.50	±0.05	±0.05	424	250	
	C1005NP0169□GTQ	1V, 1MHz	1.6	pF	±0.25pF, ±0.1pF, ±0.05pF	0.50	±0.05	±0.05	398	250	
	C1005NP0189□GTQ	1V, 1MHz	1.8	pF	±0.25pF, ±0.1pF, ±0.05pF	0.50	±0.05	±0.05	354	250	
	C1005NP0209□GTQ	1V, 1MHz	2.0	pF	±0.25pF, ±0.1pF, ±0.05pF	0.50	±0.05	±0.05	398	200	
	C1005NP0229□GTQ	1V, 1MHz	2.2	pF	±0.25pF, ±0.1pF, ±0.05pF	0.50	±0.05	±0.05	362	200	
	C1005NP0249□GTQ	1V, 1MHz	2.4	pF	±0.25pF, ±0.1pF, ±0.05pF	0.50	±0.05	±0.05	332	200	
	C1005NP0279□GTQ	1V, 1MHz	2.7	pF	±0.25pF, ±0.1pF, ±0.05pF	0.50	±0.05	±0.05	295	200	
	C1005NP0299□GTQ	1V, 1MHz	2.9	pF	±0.25pF, ±0.1pF, ±0.05pF	0.50	±0.05	±0.05	274	200	
	C1005NP0309□GTQ	1V, 1MHz	3.0	pF	±0.25pF, ±0.1pF, ±0.05pF	0.50	±0.05	±0.05	265	200	
	C1005NP0339□GTQ	1V, 1MHz	3.3	pF	±0.25pF, ±0.1pF, ±0.05pF	0.50	±0.05	±0.05	241	200	
	C1005NP0369□GTQ	1V, 1MHz	3.6	pF	±0.25pF, ±0.1pF, ±0.05pF	0.50	±0.05	±0.05	246	180	
	C1005NP0399□GTQ	1V, 1MHz	3.9	pF	±0.25pF, ±0.1pF, ±0.05pF	0.50	±0.05	±0.05	227	180	
	C1005NP0409□GTQ	1V, 1MHz	4.0	pF	±0.25pF, ±0.1pF, ±0.05pF	0.50	±0.05	±0.05	221	180	
	C1005NP0439□GTQ	1V, 1MHz	4.3	pF	±0.25pF, ±0.1pF	0.50	±0.05	±0.05	206	180	
	C1005NP0479□GTQ	1V, 1MHz	4.7	pF	±0.25pF, ±0.1pF, ±0.05pF	0.50	±0.05	±0.05	188	180	
	C1005NP0509□GTQ	1V, 1MHz	5.0	pF	±0.5pF, ±0.25pF, ±0.1pF	0.50	±0.05	±0.05	212	150	
	C1005NP0519□GTQ	1V, 1MHz	5.1	pF	±0.5pF, ±0.25pF, ±0.1pF	0.50	±0.05	±0.05	208	150	
	C1005NP0569□GTQ	1V, 1MHz	5.6	pF	±0.5pF, ±0.25pF, ±0.1pF	0.50	±0.05	±0.05	189	150	
	C1005NP0609□GTQ	1V, 1MHz	6.0	pF	±0.5pF, ±0.25pF, ±0.1pF	0.50	±0.05	±0.05	177	150	
C1005NP0629□GTQ	1V, 1MHz	6.2	pF	±0.5pF, ±0.25pF, ±0.1pF	0.50	±0.05	±0.05	171	150		
C1005NP0689□GTQ	1V, 1MHz	6.8	pF	±0.5pF, ±0.25pF, ±0.1pF	0.50	±0.05	±0.05	156	150		
C1005NP0709□GTQ	1V, 1MHz	7.0	pF	±0.5pF, ±0.25pF, ±0.1pF	0.50	±0.05	±0.05	227	100		
C1005NP0809□GTQ	1V, 1MHz	8.0	pF	±0.5pF, ±0.25pF, ±0.1pF	0.50	±0.05	±0.05	199	100		
C1005NP0829□GTQ	1V, 1MHz	8.2	pF	±0.5pF, ±0.25pF, ±0.1pF	0.50	±0.05	±0.05	194	100		
C1005NP0909□GTQ	1V, 1MHz	9.0	pF	±0.5pF, ±0.25pF, ±0.1pF	0.50	±0.05	±0.05	177	100		
C1005NP0919□GTQ	1V, 1MHz	9.1	pF	±0.5pF, ±0.25pF, ±0.1pF	0.50	±0.05	±0.05	175	100		
C1005NP0100□GTQ	1V, 1MHz	10	pF	±5%, ±2%	0.50	±0.05	±0.05	199	80		
C1005NP0120□GTQ	1V, 1MHz	12	pF	±5%, ±2%	0.50	±0.05	±0.05	221	60		
C1005NP0150□GTQ	1V, 1MHz	15	pF	±5%, ±2%, ±1%	0.50	±0.05	±0.05	265	40		
C1005NP0180□GTQ	1V, 1MHz	18	pF	±5%, ±2%	0.50	±0.05	±0.05	295	30		
C1005NP0220□GTQ	1V, 1MHz	22	pF	±5%, ±2%	0.50	±0.05	±0.05	362	20		

● C1608NP0_Q Series (EIA0603)

RV	DARFON P/N	Measuring Condition	Capacitance		Available Tolerance	Thick. (mm)	Tolerance(mm)		ESR (max.)	Q (min.)	Standard Packing
			Value	Unit			L/W	Thick.			
250V	C1608NP0308□KTQ	1V, 1MHz	0.30	pF	±0.25pF,±0.1pF, ±0.05pF	0.80	±0.10	±0.10	2122	250	Paper, 4Kpcs
	C1608NP0508□KTQ	1V, 1MHz	0.50	pF	±0.25pF,±0.1pF, ±0.05pF	0.80	±0.10	±0.10	1273	250	
	C1608NP0758□KTQ	1V, 1MHz	0.75	pF	±0.25pF,±0.1pF, ±0.05pF	0.80	±0.10	±0.10	849	250	
	C1608NP0109□KTQ	1V, 1MHz	1.0	pF	±0.25pF,±0.1pF, ±0.05pF	0.80	±0.10	±0.10	637	250	
	C1608NP0129□KTQ	1V, 1MHz	1.2	pF	±0.25pF,±0.1pF, ±0.05pF	0.80	±0.10	±0.10	663	200	
	C1608NP0159□KTQ	1V, 1MHz	1.5	pF	±0.25pF,±0.1pF, ±0.05pF	0.80	±0.10	±0.10	531	200	
	C1608NP0189□KTQ	1V, 1MHz	1.8	pF	±0.25pF,±0.1pF, ±0.05pF	0.80	±0.10	±0.10	442	200	
	C1608NP0209□KTQ	1V, 1MHz	2.0	pF	±0.25pF,±0.1pF, ±0.05pF	0.80	±0.10	±0.10	531	150	
	C1608NP0229□KTQ	1V, 1MHz	2.2	pF	±0.25pF,±0.1pF, ±0.05pF	0.80	±0.10	±0.10	482	150	
	C1608NP0279□KTQ	1V, 1MHz	2.7	pF	±0.25pF,±0.1pF, ±0.05pF	0.80	±0.10	±0.10	393	150	
	C1608NP0309□KTQ	1V, 1MHz	3.0	pF	±0.25pF,±0.1pF, ±0.05pF	0.80	±0.10	±0.10	531	100	
	C1608NP0339□KTQ	1V, 1MHz	3.3	pF	±0.25pF,±0.1pF, ±0.05pF	0.80	±0.10	±0.10	482	100	
	C1608NP0399□KTQ	1V, 1MHz	3.9	pF	±0.25pF,±0.1pF, ±0.05pF	0.80	±0.10	±0.10	408	100	
	C1608NP0479□KTQ	1V, 1MHz	4.7	pF	±0.25pF,±0.1pF, ±0.05pF	0.80	±0.10	±0.10	339	100	
	C1608NP0569□KTQ	1V, 1MHz	5.6	pF	±0.5pF, ±0.25pF,±0.1pF	0.80	±0.10	±0.10	355	80	
	C1608NP0609□KTQ	1V, 1MHz	6.0	pF	±0.5pF, ±0.25pF,±0.1pF	0.80	±0.10	±0.10	332	80	
	C1608NP0689□KTQ	1V, 1MHz	6.8	pF	±0.5pF, ±0.25pF,±0.1pF	0.80	±0.10	±0.10	293	80	
	C1608NP0829□KTQ	1V, 1MHz	8.2	pF	±0.5pF, ±0.25pF,±0.1pF	0.80	±0.10	±0.10	277	70	
	C1608NP0919□KTQ	1V, 1MHz	9.1	pF	±0.5pF, ±0.25pF,±0.1pF	0.80	±0.10	±0.10	250	70	
	C1608NP0100□KTQ	1V, 1MHz	10	pF	±5%	0.80	±0.10	±0.10	227	70	
C1608NP0120□KTQ	1V, 1MHz	12	pF	±5%	0.80	±0.10	±0.10	332	40		
C1608NP0150□KTQ	1V, 1MHz	15	pF	±5%	0.80	±0.10	±0.10	303	35		
C1608NP0180□KTQ	1V, 1MHz	18	pF	±5%	0.80	±0.10	±0.10	295	30		
C1608NP0220□KTQ	1V, 1MHz	22	pF	±5%	0.80	±0.10	±0.10	289	25		
50V	C1608NP0228□GTQ	1V, 1MHz	0.22	pF	±0.25pF±0.1pF, ±0.05pF	0.80	±0.10	±0.10	2894	250	Paper, 4Kpcs
	C1608NP0308□GTQ	1V, 1MHz	0.30	pF	±0.25pF±0.1pF, ±0.05pF	0.80	±0.10	±0.10	2122	250	
	C1608NP0508□GTQ	1V, 1MHz	0.50	pF	±0.25pF±0.1pF, ±0.05pF	0.80	±0.10	±0.10	1273	250	
	C1608NP0758□GTQ	1V, 1MHz	0.75	pF	±0.25pF±0.1pF, ±0.05pF	0.80	±0.10	±0.10	849	250	
	C1608NP0109□GTQ	1V, 1MHz	1.0	pF	±0.25pF,±0.1pF, ±0.05pF	0.80	±0.10	±0.10	637	250	
	C1608NP0129□GTQ	1V, 1MHz	1.2	pF	±0.25pF, ±0.1pF	0.80	±0.10	±0.10	663	200	
	C1608NP0159□GTQ	1V, 1MHz	1.5	pF	±0.25pF, ±0.1pF	0.80	±0.10	±0.10	531	200	
	C1608NP0189□GTQ	1V, 1MHz	1.8	pF	±0.25pF, ±0.1pF	0.80	±0.10	±0.10	442	200	
	C1608NP0209□GTQ	1V, 1MHz	2.0	pF	±0.25pF, ±0.1pF	0.80	±0.10	±0.10	531	150	
	C1608NP0229□GTQ	1V, 1MHz	2.2	pF	±0.25pF, ±0.1pF	0.80	±0.10	±0.10	482	150	
	C1608NP0279□GTQ	1V, 1MHz	2.7	pF	±0.25pF, ±0.1pF	0.80	±0.10	±0.10	393	150	
	C1608NP0309□GTQ	1V, 1MHz	3.0	pF	±0.25pF, ±0.1pF	0.80	±0.10	±0.10	531	100	
	C1608NP0339□GTQ	1V, 1MHz	3.3	pF	±0.25pF, ±0.1pF	0.80	±0.10	±0.10	482	100	
	C1608NP0399□GTQ	1V, 1MHz	3.9	pF	±0.25pF, ±0.1pF	0.80	±0.10	±0.10	408	100	
	C1608NP0479□GTQ	1V, 1MHz	4.7	pF	±0.25pF, ±0.1pF	0.80	±0.10	±0.10	339	100	
	C1608NP0569□GTQ	1V, 1MHz	5.6	pF	±0.5pF, ±0.25pF, ±0.1pF	0.80	±0.10	±0.10	355	80	
	C1608NP0609□GTQ	1V, 1MHz	6.0	pF	±0.5pF, ±0.25pF, ±0.1pF	0.80	±0.10	±0.10	332	80	
	C1608NP0689□GTQ	1V, 1MHz	6.8	pF	±0.5pF, ±0.25pF, ±0.1pF	0.80	±0.10	±0.10	293	80	
	C1608NP0829□GTQ	1V, 1MHz	8.2	pF	±0.5pF, ±0.25pF, ±0.1pF	0.80	±0.10	±0.10	277	70	
	C1608NP0919□GTQ	1V, 1MHz	9.1	pF	±0.5pF, ±0.25pF, ±0.1pF	0.80	±0.10	±0.10	250	70	
C1608NP0100□GTQ	1V, 1MHz	10	pF	±5%	0.80	±0.10	±0.10	227	70		
C1608NP0120□GTQ	1V, 1MHz	12	pF	±5%,±2%,±1%	0.80	±0.10	±0.10	332	40		
C1608NP0150□GTQ	1V, 1MHz	15	pF	±5%	0.80	±0.10	±0.10	303	35		
C1608NP0180□GTQ	1V, 1MHz	18	pF	±5%	0.80	±0.10	±0.10	295	30		
C1608NP0220□GTQ	1V, 1MHz	22	pF	±5%	0.80	±0.10	±0.10	289	25		

□ Tolerance Code: A=±0.05 pF, B=±0.1pF, C=±0.25pF, D=±0.5pF, G=±2%, J=±5%; Special tolerance on the request.

● Test Spec.

Item	Specification	Test Method																				
1	Operating Temperature Range NP0: -55 to 125 °C	---																				
2	Rated Voltage Shown in the table of "Part Number & Characteristic"	The rated voltage is defined as the maximum voltage, which may be applied continuously to the capacitor.																				
3	Appearance No defects or abnormalities.	Visual inspection																				
4	Dimensions Within the specified dimension.	Using calipers or Microscope.																				
5	Dielectric Strength (Flash) No defects or abnormalities.	No failure shall be observed when 250% of the rated voltage is applied between the terminations for 1 to 5 seconds. The charge and discharge current is less than 50mA.																				
6	Insulation Resistance (I.R.) I.R. $\geq 10G\Omega$	The insulation resistance shall be measured with a DC voltage not exceeding the rated voltage at 25°C and 75%RH max, and within 1 minute of charging.																				
7	Capacitance Within the specified tolerance	The capacitance /Q shall be measured at 25°C at the frequency and voltage shown in the tables.																				
8	Quality Factor (Q) 30pF min.: $Q \geq 1000$ 30pF max.: $Q \geq 400+20C$ C: Nominal Capacitance (pF)	<table border="1"> <tr> <td>Frequency</td> <td>1.0±0.2MHz</td> </tr> <tr> <td>Voltage</td> <td>1.0±0.2Vrms</td> </tr> </table>	Frequency	1.0±0.2MHz	Voltage	1.0±0.2Vrms																
Frequency	1.0±0.2MHz																					
Voltage	1.0±0.2Vrms																					
9	Capacitance Temperature Characteristics Capacitance change within 0±30ppm/ °C under operating temperature range.	The capacitance value at 25°C and 85°C shall be measured and calculated from the formula given below. T.C. = $(C_{85}-C_{25})/C_{25} * \Delta T * 10^6$ (PPM/°C)																				
10	Termination Strength No removal of the terminations or marking defect.	Apply a parallel force of 5N to a PCB mounted sample for 10±1sec. *2N for 0603 (EIA 0201).																				
11	Deflection (Bending Strength) No cracking or marking defects shall occur at 1mm deflection. Capacitance change: NP0: within ±5% or ± 0.5pF. (whichever is larger)	Solder the capacitor to the test jig (glass epoxy boards) shown in Fig.a using a SAC305(Sn96.5Ag3.0Cu0.5) solder. Then apply a force in the direction shown in Fig.b. The soldering shall be done with the reflow method and shall be conducted with care so that the soldering is uniform and free of defects such as heat shock.																				
	(Unit in mm) <table border="1"> <thead> <tr> <th>Size</th> <th>a</th> <th>b</th> <th>C</th> </tr> </thead> <tbody> <tr> <td>0402</td> <td>0.2</td> <td>0.56</td> <td>0.23</td> </tr> <tr> <td>0603</td> <td>0.3</td> <td>0.9</td> <td>0.3</td> </tr> <tr> <td>1005</td> <td>0.4</td> <td>1.5</td> <td>0.5</td> </tr> <tr> <td>1608</td> <td>1.0</td> <td>3.0</td> <td>1.2</td> </tr> </tbody> </table> Fig. a.	Size	a	b	C	0402	0.2	0.56	0.23	0603	0.3	0.9	0.3	1005	0.4	1.5	0.5	1608	1.0	3.0	1.2	Fig. b.
Size	a	b	C																			
0402	0.2	0.56	0.23																			
0603	0.3	0.9	0.3																			
1005	0.4	1.5	0.5																			
1608	1.0	3.0	1.2																			
12	Solderability of Termination 90% of the terminations are to be soldered evenly and continuously. C0402 Series: 75% of the terminations are to be soldered evenly and continuously.	Immerse the test capacitor into a methanol solution containing rosin for 3 to 5 seconds, preheat it 150 to 180°C for 2 to 3 minutes and immerse it into SAC305(Sn96.5Ag3.0Cu0.5) solder of 245 ± 5°C for 3±1seconds.																				
13	Resistance to Soldering Heat	Immerse the capacitor in a SAC305(Sn96.5Ag3.0Cu0.5) solder solution at 270±5°C for 10±1 seconds. Let sit at room temperature for 24±2 hours, then measure. *C0402 Series is not suitable for this testing																				
	Appearance		No marking defects																			
	Cap. Change		NP0 within ±2.5% or ±0.25pF (whichever is larger)																			
	Q		Initial spec.																			
	I.R.	Initial spec.																				

Item		Specification	Test Method
14	Temperature cycle (Thermal shock)	Appearance	Solder the capacitor to supporting jig (glass epoxy board) and perform the five cycles according to the four heat treatments listed in the following table. Let sit for 24±2hrs at room temperature, then measure. Step 1: Minimum operating temperature 30±3min Step 2: Room temperature 2~3 min Step 3: Maximum operating temperature 30±3min Step 4: Room temperature 2~3min
		Cap. Change	
		Q	
		I.R.	
15	Humidity load	Appearance	Apply the rated voltage at 40±2°C and 90 to 95% humidity for 500±12 hours. Remove and let sit for 24±2 hours at room temperature, then measure. The charge / discharge current is less than 50mA.
		Cap. Change	
		Q	
		I.R.	
16	High temperature load life test	Appearance	Apply 200% of the rated voltage for 1000±12 hours at the maximum operating temperature ± 3°C. Let sit for 24± 2 hours at room temperature, then measure. The charge/discharge current is less than 50mA.
		Cap. Change	
		Q	
		I.R.	
17	ESR & Q	Shown in the table of "Part Number & Characteristic"	Testing frequency is shown in the table of "Part Number & Characteristic"

Package

- Tape and reel packaging**

Tape and reel packaging is currently the most promising system for high-speed production. A typical 180mm (7 inch) diameter reel contains 1,500 to 15,000 capacitors, 250mm (10 inch) contains 10,000 capacitors, and 330mm (13 inch) contains 10,000 to 50,000 capacitors. Three standard sizes are available in taped and reeled package either with paper carrier tapes or embossed tapes.

【Paper tape specifications】

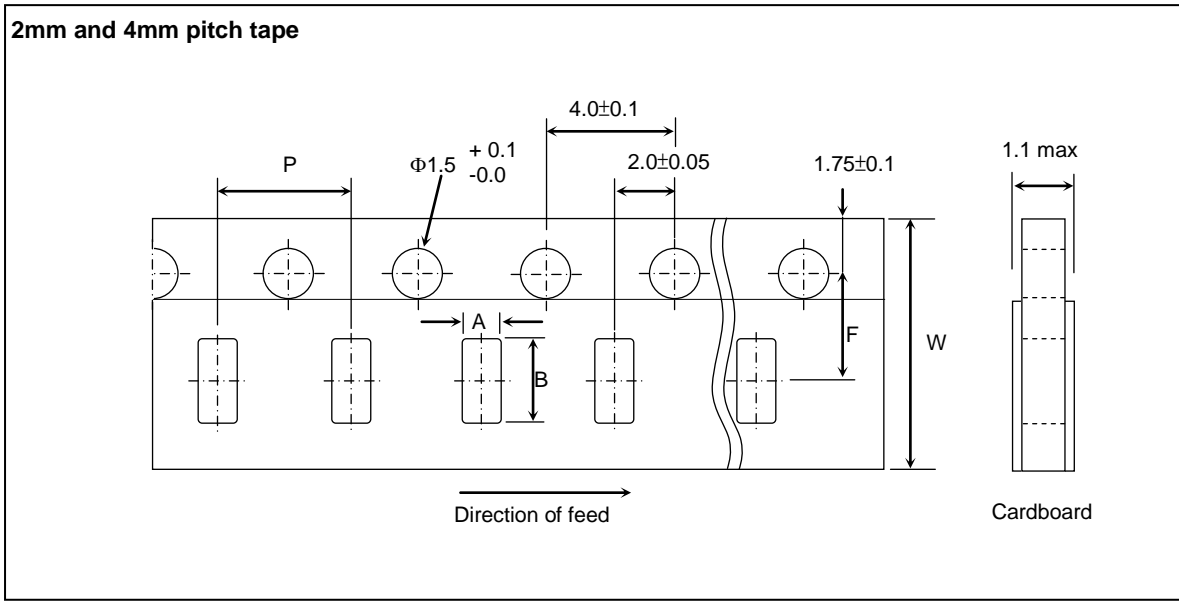

SYMBOL	PRODUCT SIZE CODE								UNIT
	1005(0402) (±0.05 mm)		1005(0402) (±0.10 mm)		1005(0402) (±0.15 mm)		1005(0402) (±0.20 mm)		
	SIZE	TOL.	SIZE	TOL.	SIZE	TOL.	SIZE	TOL.	
A	0.65	± 0.10	0.70	± 0.10	0.72	± 0.10	0.80	± 0.10	mm
B	1.15	± 0.10	1.19	± 0.10	1.25	± 0.10	1.35	± 0.10	mm
F	3.5	± 0.05	3.5	± 0.05	3.5	± 0.05	3.5	± 0.05	mm
P	2	± 0.10	2	± 0.10	2	± 0.10	2	± 0.10	mm
W	8	± 0.20	8	± 0.20	8	± 0.20	8	± 0.20	mm

SYMBOL	PRODUCT SIZE CODE (EIA)				UNIT
	1608 (0603) (±0.15 mm)		1608 (0603) (±0.20 mm)		
	Size	Tol.	Size	Tol.	
A	1.0	±0.2	1.1	±0.2	mm
B	1.8	±0.2	1.9	±0.2	mm
F	3.5	±0.05	3.5	±0.05	mm
P	4	±0.1	4	±0.1	mm
W	8	±0.2	8	±0.2	mm

【Reel specifications】

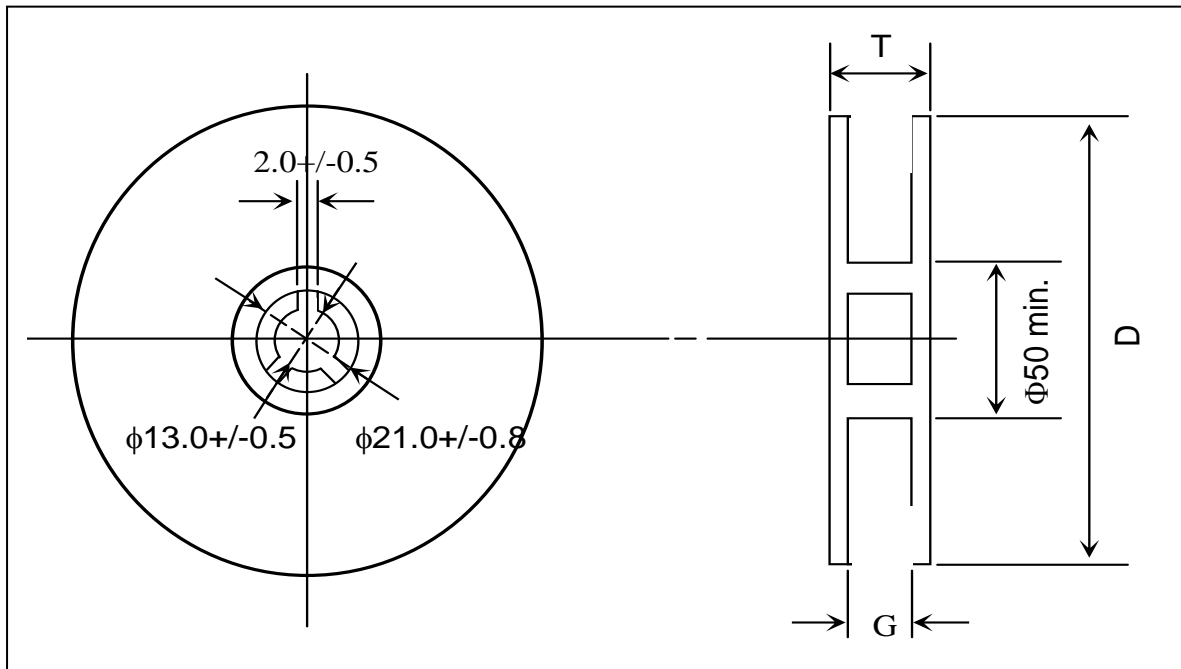

TAPE WIDTH (mm)	G (mm)	T max. (mm)	D (mm)
4	5.0 ± 1.5	8.0	180
8	10.0 ± 1.5	14.5	180
8	10.0 ± 1.5	14.5	250
8	10.0 ± 1.5	14.5	330
12	14.0 ± 1.5	18.5	180

【Thickness and Packing Amount】

Thickness			Amount per reel			
Code	Spec.(mm)	Size (EIA)	180 mm (7")		330 mm (13")	
			Paper	Embossed	Paper	Embossed
B	0.50	1005 (0402)	10K		50K	
D	0.80	1608 (0603)	4K	4K	15K	

【Packing Rule】

EIA SIZE	Tape	Reel Size	Reels/Box	Boxes/ Carton
0402	Paper	7"	5	12
0603	Paper/Emboss	7"	5	12

Others

【Storage】

1. The chip capacitors shall be packaged in carrier tapes or bulk cases.
2. Keep storage place temperatures from +5°C to +35°C, humidity from 45 to 70% RH.
3. The storage atmosphere must be free of gas containing sulfur and chlorine. Also, avoid exposing the product to saline moisture. If the product is exposed to such atmospheres, the terminations will oxidize and solderability will be affected.
4. The solderability is assured for 12 months from our final inspection date if the above storage condition is followed.

【Circuit Design】

1. Once application and assembly environments have been checked, the capacitor may be used in conformance with the rating and performance, which are provided in both the catalog and the specifications. Exceeding the specifications listed may result in inferior performance. It may also cause a short, open, smoking, or flaming to occur, etc.
2. Please use the capacitors in conformance with the operating temperature provided in both the catalog and the specifications. Be especially cautious not to exceed the maximum temperature. In the situation the maximum temperature set forth in both the catalog and specifications is exceeded, the capacitor's insulation resistance may deteriorate, power may suddenly surge and short-circuit may occur. The loss of capacitance will occur, and may self-heat due to equivalent series resistance when alternating electric current is passed through. As this effect becomes critical in high frequency circuits, please exercise with caution. When using the capacitor in a (self-heating) circuit, please make sure the surface of the capacitor remains under the maximum temperature for usage. Also, please make certain temperature rise remain below 20°C.
3. Please keep voltage under the rated voltage, which is applied to the capacitor. Also, please make certain the peak voltage remains below the rated voltage when AC voltage is super-imposed to the DC voltage. In the situation where AC or pulse voltage is employed, ensure average peak voltage does not exceed the rated voltage. Exceeding the rated voltage provided in both catalog and specifications may lead to defective withstanding voltage or, in worse case situations, may cause the capacitor to burn out.
4. It's is a common phenomenon of high-dielectric products to have a deteriorated amount of static electricity due to the application of DC voltage.

【Handling】

Chip capacitors should be handled with care to avoid contamination or damage. The use of vacuum pick-up or plastic tweezers is recommended for manual placement. Tape and reeled packages are suitable for automatic pick and placement machine.

【Flux】

1. An excessive amount of flux or too rapid temperature rise can causes solvent burst, solder can generate a large quantity of gas. The gas can spreads small solder particles to cause solder balling effect or bridging problem.
2. Flux containing too high of a percentage of halide may cause corrosion of termination unless sufficient cleaning is applied.
3. Use rosin-type flux. Highly acidic flux (halide content less than 0.2wt%) is not recommended.
4. The water soluble flux causes deteriorated insulation resistance between outer terminations unless sufficiently cleaned.

【Component Spacing】

For wave soldering components, the spacing must be sufficient far apart to prevent bridging or shadowing. This is not so important for reflow process but enough space for rework should be considered. The suggested spacing for reflow soldering and wave soldering is 0.5mm and 1.0mm, respectively.

【Solder Fillet】

Too much solder amount may increase solder stress and cause crack risk. Insufficient solder amount may reduce adhesive Strength and cause parts falling off PCB. When soldering, confirm that the solder is placed over 0.2mm of the surface of the terminations.

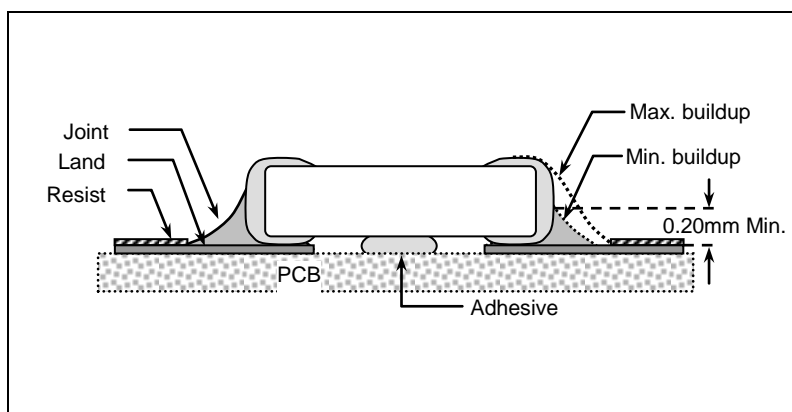

【Recommended Land Pattern Dimensions】

When mounting the capacitor to substrate, it's important to consider that the amount of solder (size of fillet) used has a direct effect upon the capacitor once it's mounted.

1. The greater the amount of solder, the greater the stress to the elements, as this may cause the substrate to break or crack.
2. In the situation where two or more devices are mounted onto a common land, separate the device into exclusive pads by using soldering resist.
3. Land width equal to or less than component. It is permissible to reduce land width to 80% of component width.

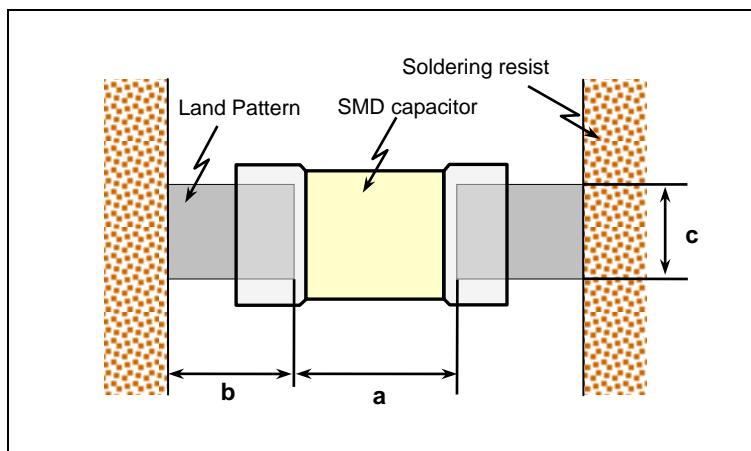

Size mm (EIA)	L x W (mm) (Dimension tolerance)	a (mm)	b (mm)	c (mm)
1005 (0402)	1.0*0.5 (within±0.10)	0.3 to 0.5	0.35 to 0.45	0.4 to 0.5
	1.0*0.5 (±0.15 or ±0.20)	0.4 to 0.6	0.4 to 0.5	0.5 to 0.6
1608 (0603)	1.6*0.8 (within±0.10)	0.7 to 1.0	0.6 to 0.8	0.7 to 0.8
	1.6*0.8 (±0.15 or ±0.20)	0.8 to 1.1	0.7 to 0.9	0.8 to 0.9

[Resin Mold]

If a large amount of resin is used for molding the chip, cracks may occur due to contraction stress during curing. To avoid such cracks, use a low shrinkage resin. The insulation resistance of the chip will degrade due to moisture absorption. Use a low moisture absorption resin. Check carefully that the resin does not generate a decomposition gas or reaction gas during the curing process or during normal storage. Such gases may crack the chip capacitor or damage the device itself.

[Soldering Profile for SMT Process with SnPb Solder Paste]

Reflow Soldering

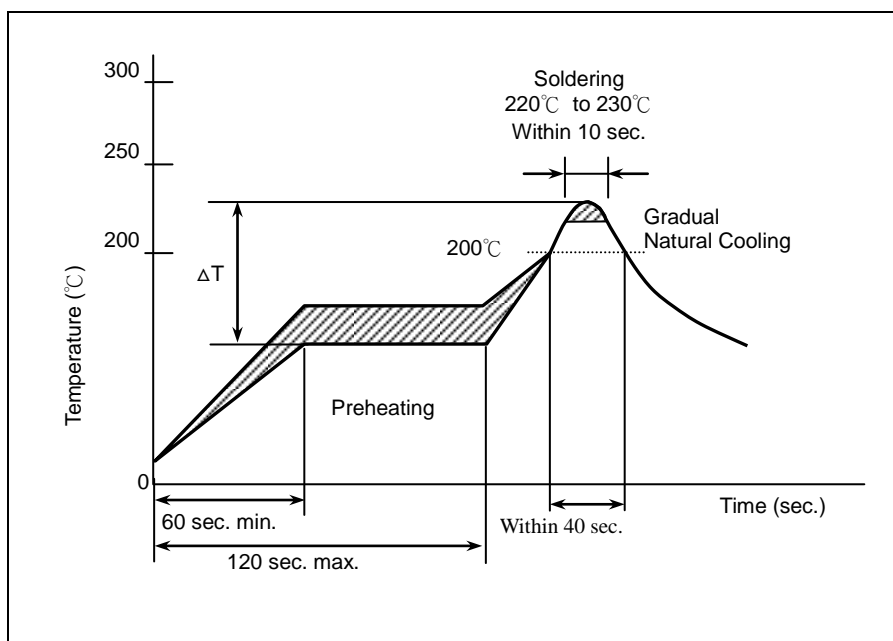

The difference between solder and chip surface should be controlled as following table. The rate of preheat should not exceed 4°C/sec and a target of 2°C/sec is preferred.

Chip Size	3216 and smaller	3225 and above
Preheating	$\Delta T \leq 150^\circ\text{C}$	$\Delta T \leq 130^\circ\text{C}$

Wave Soldering

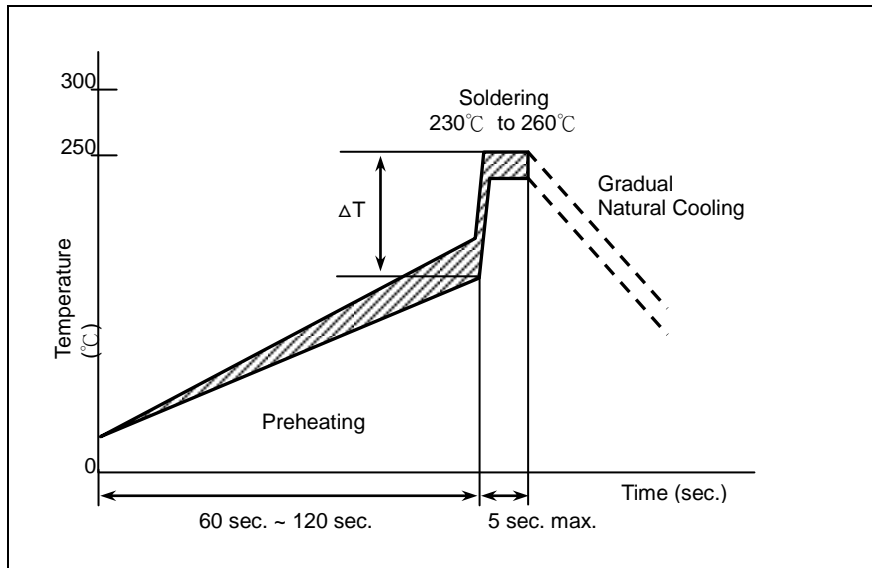

Chip Size	3216 and smaller	3225 and above
Preheating	$\Delta T \leq 150^\circ\text{C}$	-

Soldering Iron

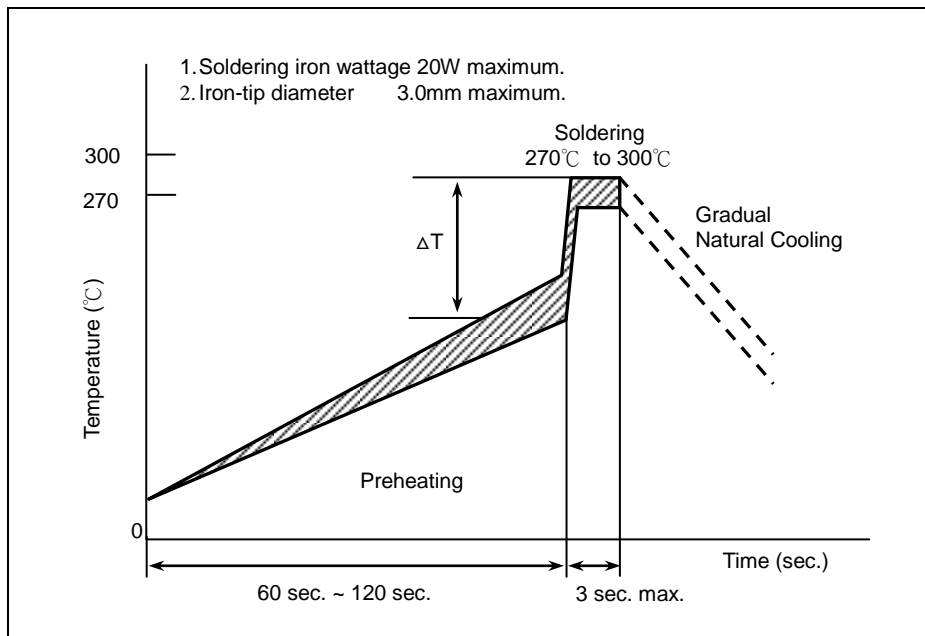

Chip Size	3216 and smaller	3225 and above
Preheating	$\Delta T \leq 190^\circ\text{C}$	$\Delta T \leq 130^\circ\text{C}$

[Soldering]

Reflow Soldering for Lead free Termination

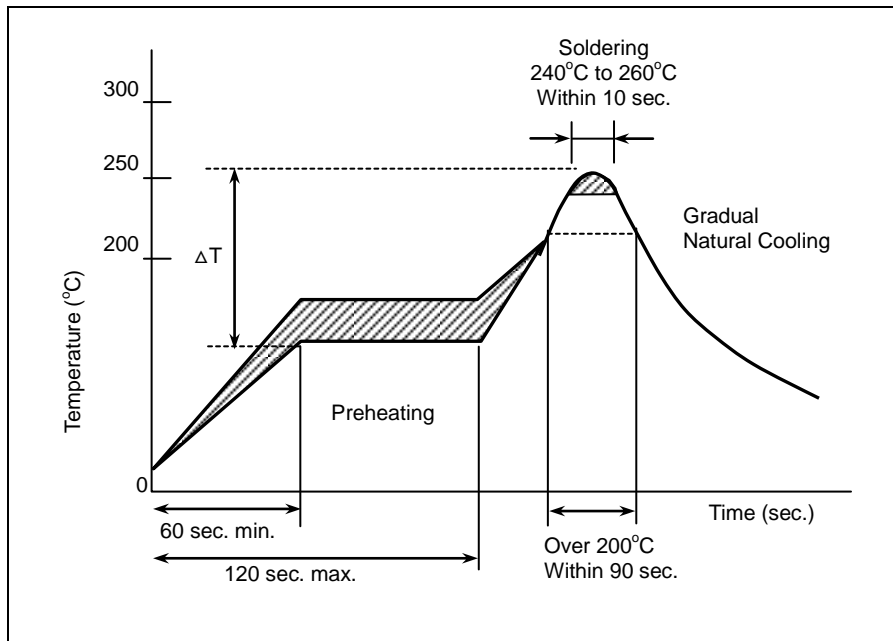

The difference between solder and chip surface should be controlled as following table. The rate of preheat should not exceed 4°C/sec and a target of 2°C/sec is preferred.

Chip Size	3216 and smaller	3225 and above
Preheating	$\Delta T \leq 150^\circ\text{C}$	$\Delta T \leq 130^\circ\text{C}$

Flow Soldering for Lead free Termination

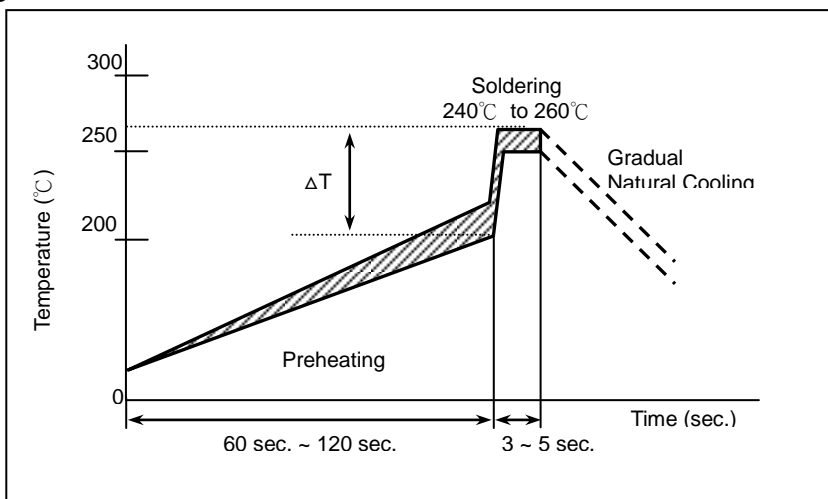

Chip Size	3216 and smaller	3225 and above
Preheating	$\Delta T \leq 150^\circ\text{C}$	-

MLCC

Soldering Iron

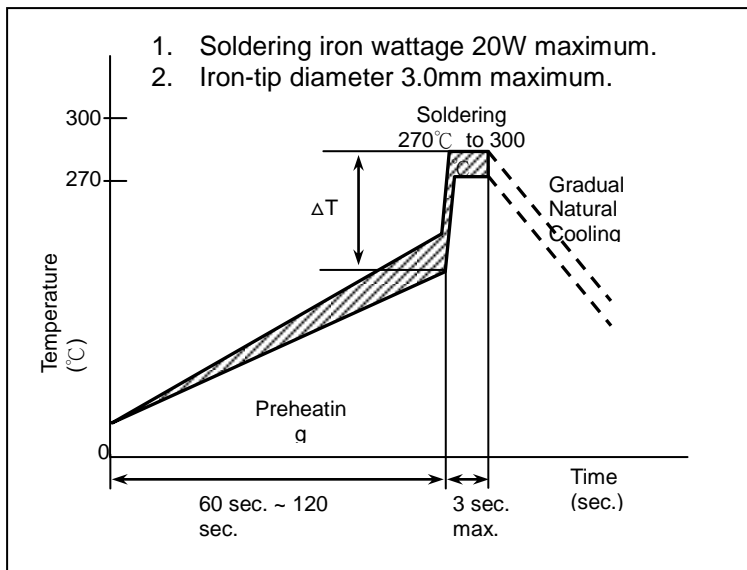

Chip Size	3216 and smaller	3225 and above
Preheating	$\Delta T \leq 190^{\circ}\text{C}$	$\Delta T \leq 130^{\circ}\text{C}$

【Chip Layout and Breaking PCB】

- To layout the SMD capacitors for reducing bend stress from board deflection of PCB. The following are examples of Hood and bad layout.

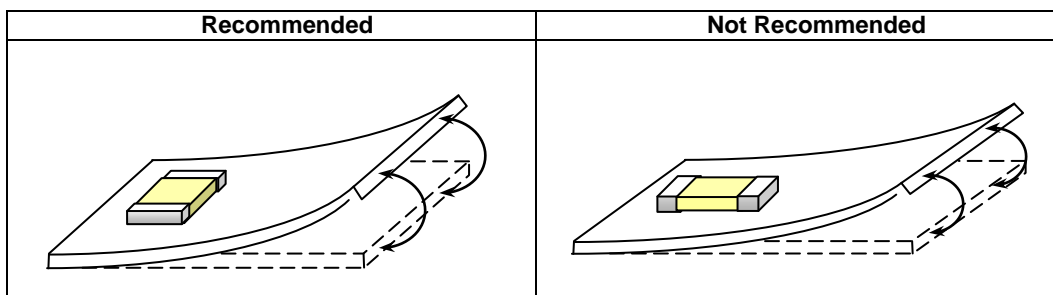

- When breaking PCB, the layout should be noted that the mechanical stresses are depending on the position of capacitors. The following example shows recommendation for better design.

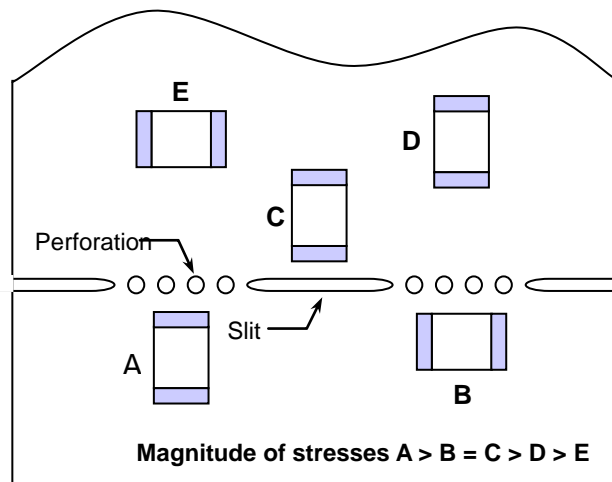

【Aging Rate】

The capacitance and dissipation factor of class 2 capacitors decreases with time. It is known as ‘aging’ that follows a logarithmic law and expressed in terms of an aging constant. Aging is caused by a gradual re-alignment of the crystalline structure of the ceramic. The aging constant is defined as the percentage loss of capacitance at a ‘time decade’. The law of capacitance aging is expressed as following equation:

Typical Curve of Aging Rate of Different Dielectric Material

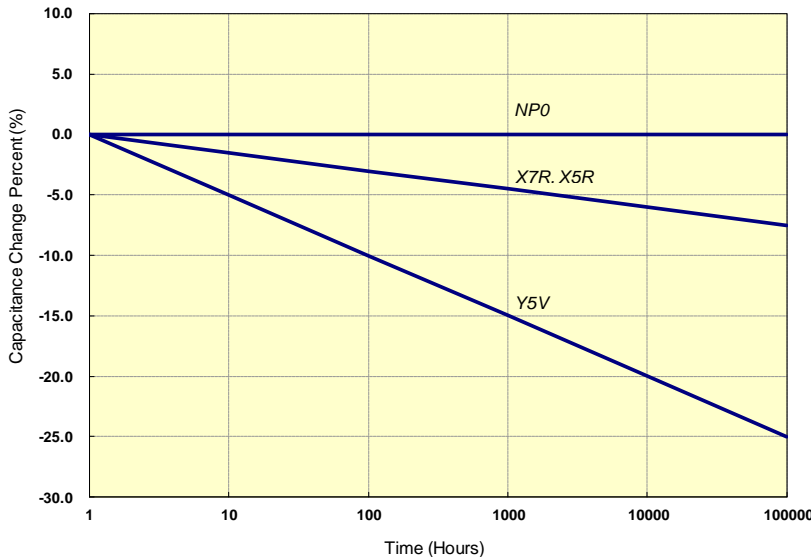

$$C_{t_2} = C_{t_1} \times (1 - k \times \log_{10}(t_2/t_1))$$

C_{t1}: Capacitance after *t₁* hours of start aging.

C_{t2}: Capacitance after *t₂* hours of start aging.

k: aging constant (capacitance decrease per decade)

t₁, *t₂*: time in hours from start of aging.

A typical curve of aging rate is shown in following figure.

When heating the capacitors above Curie temperature (130°C~150°C) the capacitance can be re-new. So capacitance of class 2 capacitors will be complete de-aged by soldering process; subsequently a new aging process begins.

Because of aging, it is specified an age for measurement to meet the prescribed tolerance for class 2 capacitors. Normally, 1000 hours (*t₂*=1000 hrs) is defined.

【Peeling Off Force】

Peeling off force: 0.1N to 1.0 N* in the direction shown as below.

The peeling speed: 300±10 mm/min

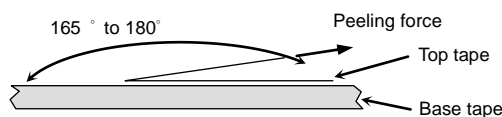

1. The taped tape on reel is wound clockwise. The sprocket holes are to the right as the tape is pulled toward the user.
2. There are minimum 150 mm as the leader and minimum 40 mm empty tape as the tail is attached to the end of the tape.